

2+4 DRAWER CHEST

Stock number: 403X-76

Thank you for purchasing this product. Please read the instructions carefully before use to ensure safe and satisfactory operation of this product.

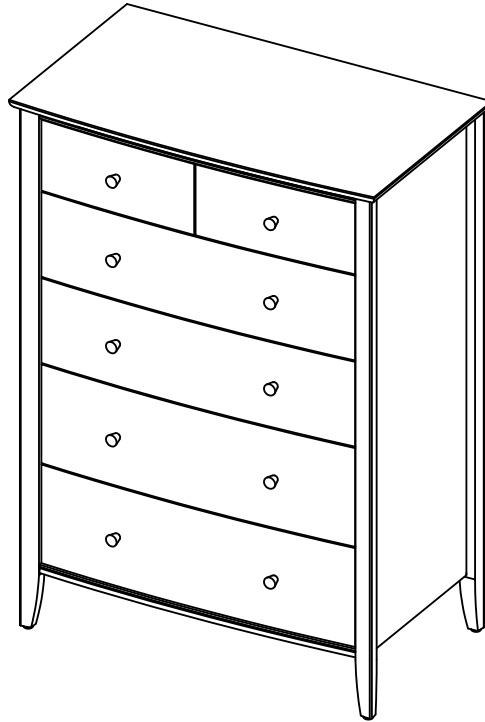

Pre-assembly preparation

Please ensure instructions are read in full before attempting to assemble this product.

Necessary Tools :

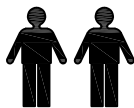

Please check the pack contents before attempting to assemble this product. A full checklist of components is given in this leaflet. If any components are missing, please contact the retailer from whom you bought this product.

This product takes approximately **10 MINUTES** to assemble with **2 PEOPLE**.

All assembly should be performed on a flat, stable, clean and soft surface.

This product is **HEAVY**, it should be assembled as near as possible to the point of use. **TAKE CARE WHEN LIFTING** to avoid personal injury and (or) damage to the product.

The fitting pack contains **SMALL ITEMS** which should be **KEPT AWAY FROM YOUNG CHILDREN**.

IMPORTANT: Retain these instructions for future reference.

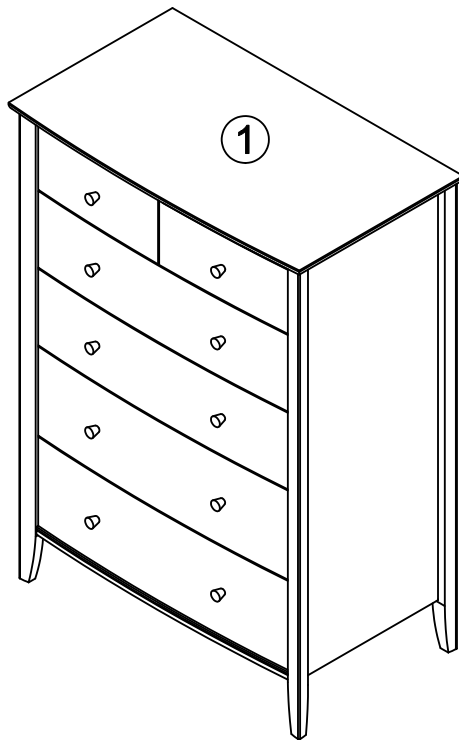

Fittings and parts checklist

Item	Description	Qty.	Item	Description	Qty.
1	Unit	x 1	A	Felt 	x 4

Step By Step Assembly Instructions

- Step 1**
- 1.1: Lay the unit on a flat, stable, clean and soft surface.
 - 1.2: Remove the plastic from 4x felts (A) and stick felts (A) onto under legs as shown.
 - 1.3: Stand the unit upright.

Fitting



A x 4

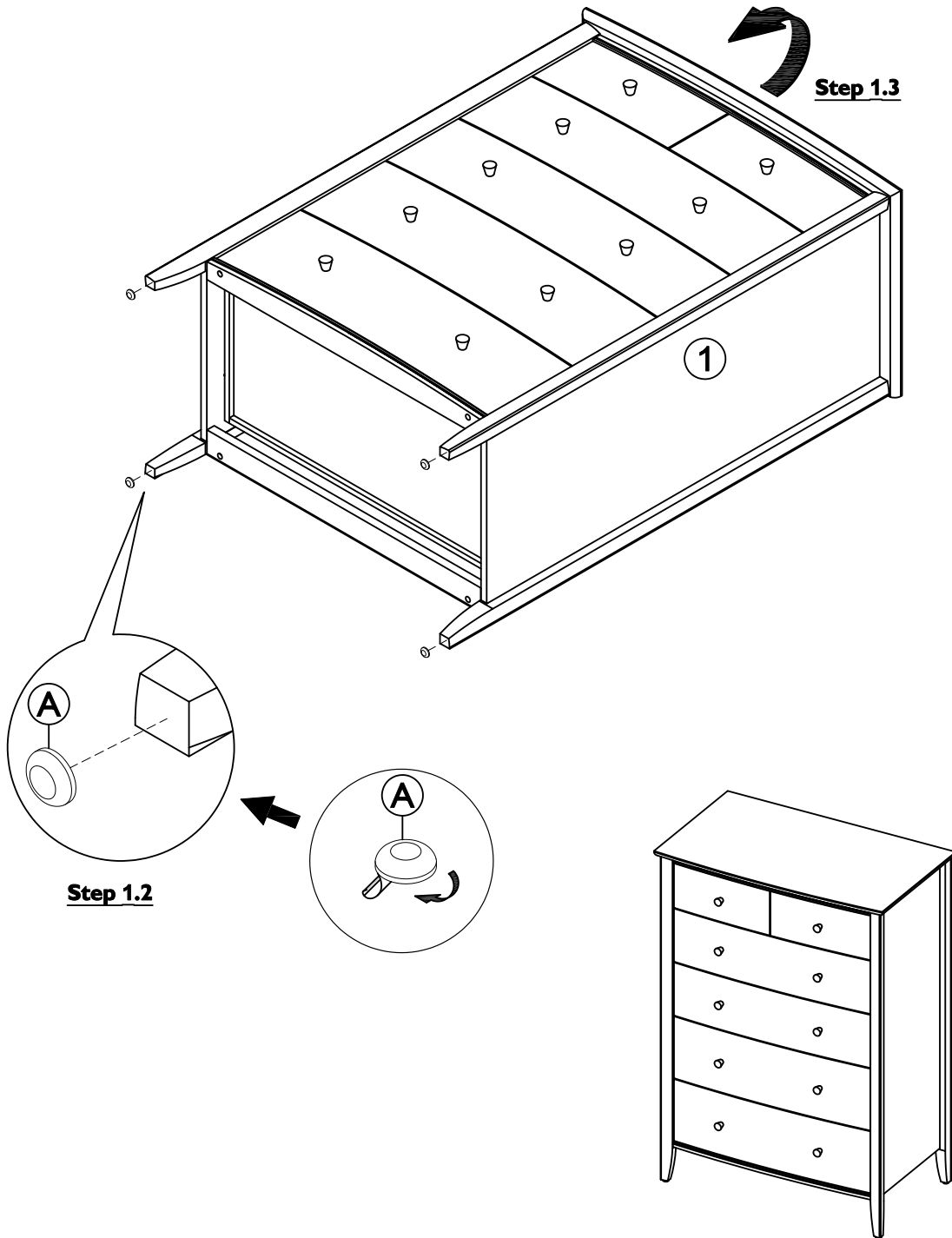

Assembly is complete

Care and Maintenance

Wood Furniture

Wood displays different grain patterns depending on which way they are cut - for example, the 'medullary ray' which can appear on oak furniture is a mark of good quality timber - these are just characteristics of the natural beauty of the wood.

Some furniture is also deliberately aged and rustic.

Wood veneers also allow distinctive patterns to be created on some surfaces, such as table tops and drawer fronts by the way slivers are arranged.

All timber and veneer surfaces will change colour and mellow over time. New furniture will initially vary in shade from items that have been previously purchased.

How to care for your wood furniture

Dust with a clean, damp, lint free cloth. Frequent dusting will remove abrasive build up, which can damage the finish over time.

Do not use a very wet cloth or allow any liquid to contact with the veneers for a long period of time as this can permanently damage the surface. Wipe up spills immediately.

Do not use any abrasive cleaner or harsh detergent as this can damage the surface of the furniture.

Spray polishes are best avoided as they contain silicones which may spoil the furniture's surface when building up over time.

Make sure all surfaces are protected from heat and liquids by mats and coasters.

Ensure that a mat or pad is placed under paper when you are writing on the furniture surface.

Do not place rubber, cork, vinyl or plastic materials on the wood finish as chemicals within may react with the finish if left in contact for an extended period of time.

Our furniture will endure most temperatures in the home but it is best to avoid placing furniture next to heat sources such as radiators or fires. Be particularly careful with solid wood as the lack of humidity caused by home heating can cause damage such as warping, cracking or splitting.

Excessive exposure to sunlight can cause fading of your furniture.

Avoid exposing your furniture to any liquids. All liquids should be wiped up immediately with a soft, slightly damp cloth in the direction of the wood grain. If sticky liquid residues do occur, they may be removed with a dilute solution of warm soapy water followed by a clean, damp sponge. The area should then be wiped immediately in the direction of the wood grain with a clean, soft white cloth until completely dry.

Nail polish remover, hairspray, perfume, potpourri & any other products that contains solvents can damage wood upholstery finishes.

Safety Instructions:

Never drag furniture when moving it. Always lift it.

Periodically check all fixings to ensure none have come loose. Re-tighten when necessary.

Please take care when handling or moving the furniture as careless handling may cause damage or injury.

Furniture can be dangerous if incorrectly assembled. Assembly should be carried out by a competent person.

No liability will be accepted for damage or injury caused by incorrectly installed or assembled furniture.

Heavy item warning:

It is recommended to seek assistance when moving a heavy object. Take care when lifting to avoid personal injury and (or) damage to the product.

It is recommended that before moving a heavy object to a new location it is completely dis-assembled to avoid personal injury or damage to the furniture. Please be careful to retain all fittings when doing this.